

UMB-A19-03

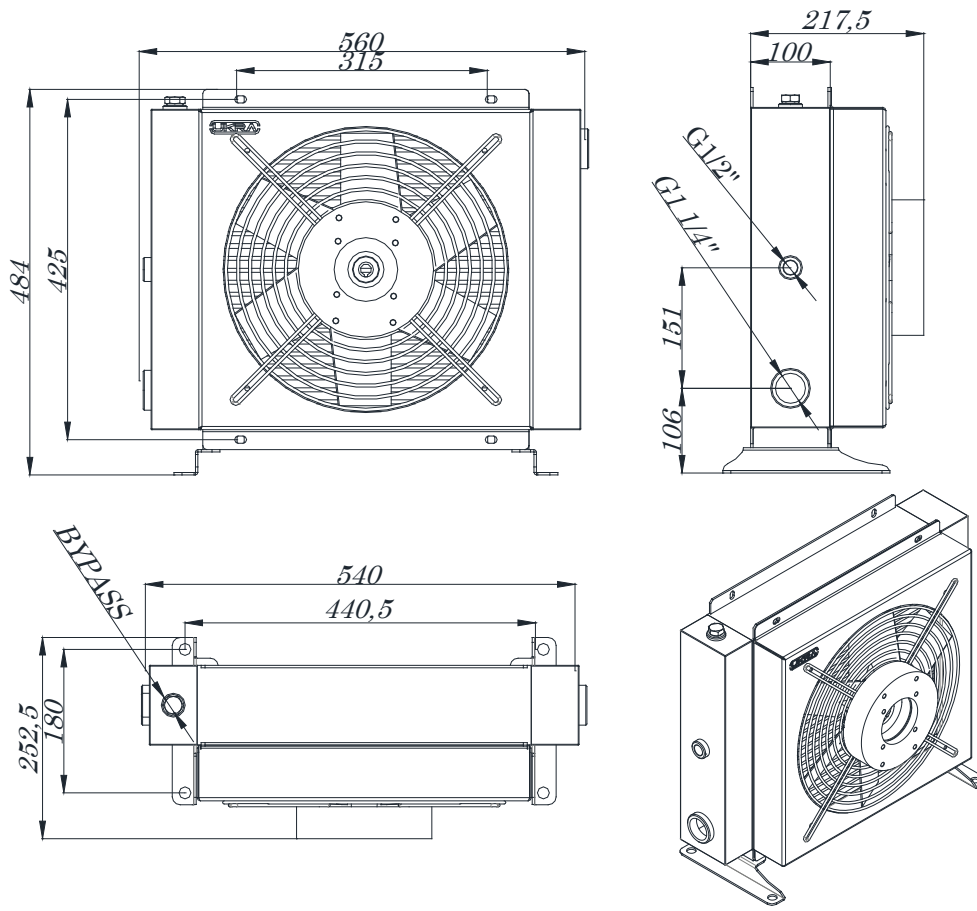

PRODUCT	OIL FLOW MIN-MAX	MAX COOLING CAPACITY	VOLTAGE	POWER	AIR	Ø FAN	FAN SPEED	ELECTRIC PROTECTION	CAPACITY	WEIGHT
	L/min	KW	V	W	m ³ /h	mm	RPM	IP	L	Kg
UMB - A19 - 03	150 - 250	40			4,080	ø350	1,500		9	28

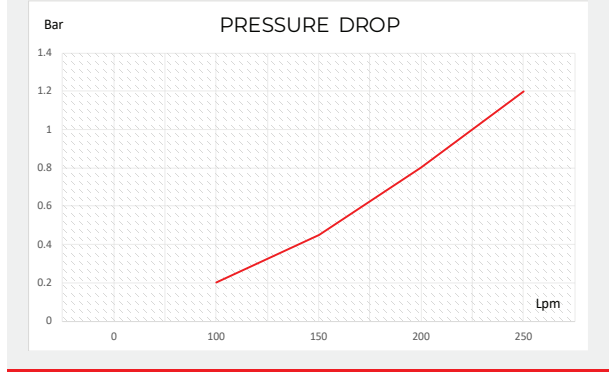
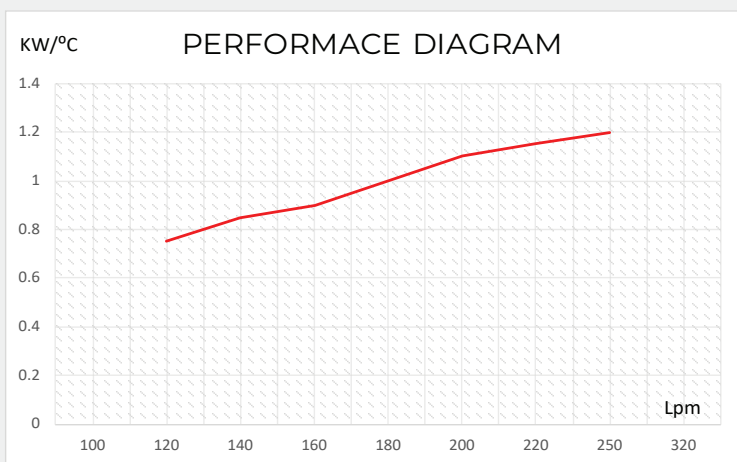

cSt	10	15	20	30	40	50	60	80	100	200	300
Pd	0.5	0.65	0.77	1	1.2	1.4	1.6	1.9	2.1	3.3	4.3