

UMB-A16-01

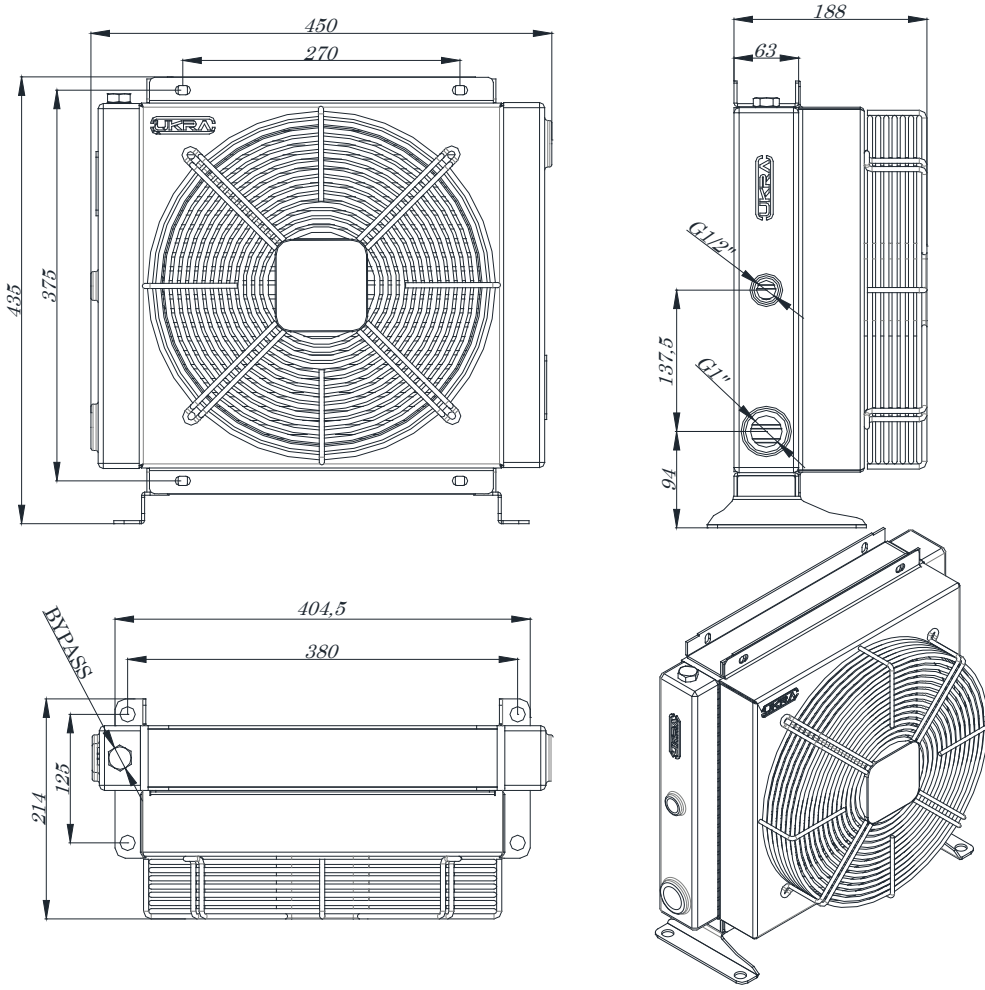

PRODUCT	OIL FLOW MIN-MAX	MAX COOLING CAPACITY	VOLTAGE	POWER	AIR	Ø FAN	FAN SPEED	ELECTRIC PROTECTION	CAPACITY	WEIGHT
	L/min	KW	V	W	m³/h	mm	RPM	IP	L	Kg
UMB - A16 - 01	80 - 140	25	230 AC	72	1,710	ø300	1.300	54	4	14

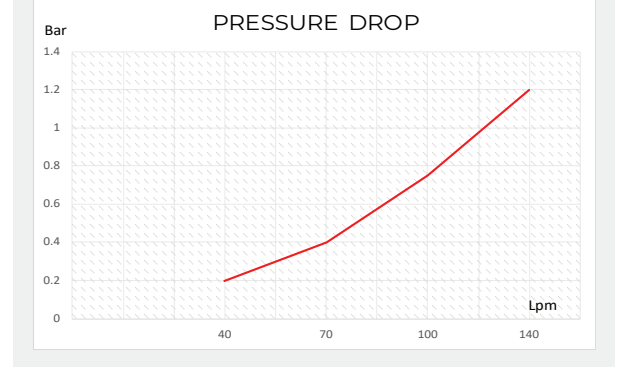
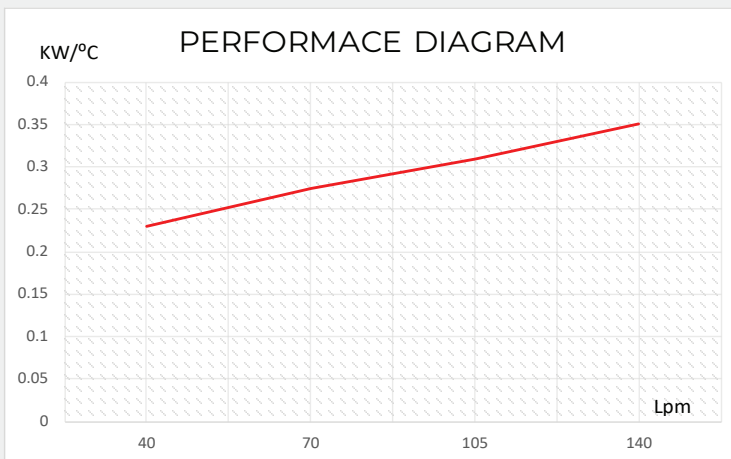

cSt	10	15	20	30	40	50	60	80	100	200	300
Pd	0.5	0.65	0.77	1	1.2	1.4	1.6	1.9	2.1	3.3	4.3